

# 85F1.85 DF DSM 中远摄定焦镜头

## 使用说明书 for S

### 感谢您购买永诺产品！

在使用本产品前，请务必先仔细阅读本手册，以确保您能正确、安全使用。请妥善保管好本手册，以便日后能随时查阅。

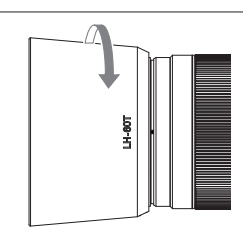
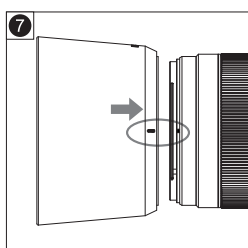
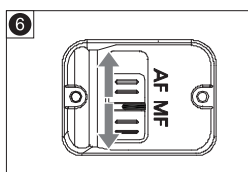
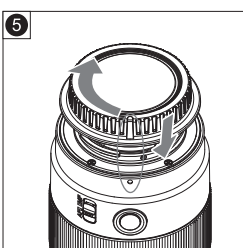
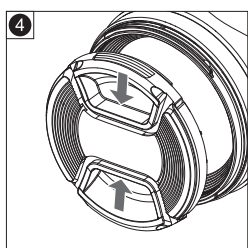
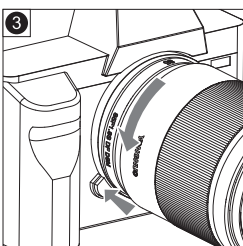
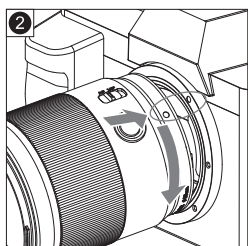
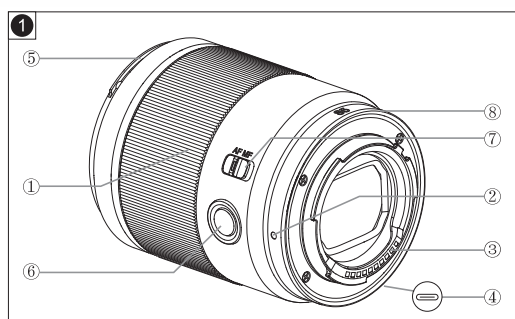

### 安全注意事项

- 请勿透过镜头或相机观看太阳或明亮的光源，否则会使视力受损。
- 无论镜头是否装在相机上，请勿将没有盖镜头盖的镜头置于太阳下，否则镜头可能汇聚光线并引发火灾。不使用时请盖上镜头盖。
- 请将镜头放置在儿童接触不到的地方。
- 请勿自行拆开或改造镜头。

### 部件说明 ①

- |           |          |
|-----------|----------|
| ① 手动对焦环   | ② 镜头安装标记 |
| ③ 电子触点    | ④ USB接口  |
| ⑤ 遮光罩安装标记 | ⑥ Fn按钮   |
| ⑦ 对焦模式开关  | ⑧ 橡胶圈    |

### 安装与卸下镜头

详细安装及卸下镜头的步骤请参阅相机使用说明书。

#### 安装镜头 ②

将镜头上的白色安装标志对准相机上的相同安装标志，然后以顺时针方向旋转镜头，直到听到“咔”的一声为止。

#### 卸下镜头 ③

按下相机上的镜头释放按钮，逆时针方向转动镜头直至停止，然后卸下镜头。

- 卸下镜头后，请将镜头后端朝上放置，以避免划伤镜头表面和电子触点。如果电子触点被弄脏或沾有指纹，请用柔软的布将其擦净。
- 取下镜头时，需要装上防尘盖。请正确安装防尘盖 ⑤ 将防尘盖上的安装标记对准镜头上的相同安装标记，朝顺时针方向旋转。要取下镜头盖则朝逆时针方向旋转。

### 对焦模式 ④

镜头支持自动对焦和手动对焦。镜头上设置对焦模式，将对焦模式开关滑动到相应位置即可。相机上设置对焦模式请参考相机说明书。

**进行AF拍摄：**相机和镜头均需设置为AF。

**进行MF拍摄：**仅需将相机和镜头中的一个设为MF，或两者都设为MF。

- 镜头未安装到相机上或相机关机时，不能调整对焦。

### 使用Fn多功能按钮

通过相机“对焦保持按钮”自定义设置，可为Fn自由分配所需功能。合理分配Fn按钮可快速调出某一功能菜单或执行某一快捷操作，以减少翻找相机菜单的时间，提高创作效率。

- Fn自定义功能设置需相机支持，具体详情请参考相机说明书。

### 遮光罩

安装遮光罩可以保护镜头和阻挡可能导致杂光或鬼影的散射光线。

**安装：**将遮光罩上的安装标记与镜头前端的安装标记对齐，然后顺时针转动遮光罩直至停止。⑦

**拆卸：**逆时针旋转遮光罩直至停止，然后取下遮光罩。

- 遮光罩可反向安装以便存放。
- 遮光罩安装不当，可能会遮挡部分图像。
- 使用内置闪光灯或使用相机上安装的外部闪光灯时，建议取下遮光罩，以免挡住闪光灯光线。

### 滤光镜（需另购）

可在镜头前端的螺纹上安装一个直径58mm的滤光镜。

- 每次只能安装一个滤光镜。

### 固件升级

本产品支持固件升级，您可以登录网站 <https://www.hkyongnuo.com/xzyzc> 下载最新升级软件和最新固件。使用前，建议升级到最新固件以获取最佳使用体验。

升级方法为：将镜头从相机上取下，通过USB Type-C线（需另购）与电脑连接，打开升级软件并按照软件提示完成升级操作。

### 保养及存放注意事项

- 应避免撞击或直接放置在酷热、极冷或潮湿的环境下。
- 如果长期存放，请选择阴凉凉爽及通风良好的地方。建议远离防虫丸或防虫丸发出气体的地方，以保护镜头的镀膜层。
- 镜片上的污垢或者指纹可用柔软微湿的镜头布或镜头纸清洁，切勿使用溶剂、苯或其他有机清洁剂。
- 下雨或者接近水源使用时须特别小心，切勿弄湿。倘若内部机件、镜片及电子零件因弄湿受损，很可能无法维修。
- 温度突变可能会令镜头表面凝结雾气或水珠，因此在天气寒冷时进入暖和的室内环境，最好将镜头放在密封的塑胶袋内，直至镜头温度接近室温为止。将镜头从温暖的环境拿到寒冷的环境中时，也请使用同样的方法。

### 故障排除

#### 1. 手动对焦时已经调至最清晰，但成像依然是模糊的

请检查镜头两端镜片是否存在指纹或污垢，如果存在请使用柔软微湿的镜头布或擦镜纸擦拭干净。

#### 2. 无法自动对焦

进行AF拍摄时，请确保相机和镜头的对焦模式均已设为AF。

#### 3. 镜头装相机上通信异常

请确保镜头安装到位；请检查镜头触点和相机触点是否被弄脏或划伤，如果被弄脏请用柔软的布将其擦净，如果被划伤请返厂维修。

#### 4. 其他异常情况

请尝试关闭相机电源并取出相机电池，然后装回电池再重启电源试试。如果仍有异常，请致电永诺售后服务中心400-001-3888或发送邮件至service@hkyongnuo.com进行咨询。

### 规格

镜头焦距		85mm
视角范围	对角线	28.83°
	垂直	16.5°
	水平	24.12°
卡口		E卡口
画幅		全画幅
镜头结构		8组9片
光圈叶片		7
最小光圈		F/16
最近对焦距离		0.8m
最大放大倍率		0.13x
驱动系统		数控步进马达
滤光镜直径		58mm
最大直径及长度		约φ67×87mm
重量		约 385g

■ 镜头长度是指从安装面到镜头前端的距离。

■ 除特别说明外，尺寸和重量只适用于镜头。

■ 光圈设置可以由相机指定。

本说明书最新电子版可在永诺官方网站 <https://www.hkyongnuo.com/xzyzc> 获取。

本使用说明书中的功能及数据均是依据本公司的测试条件获得。设计和规格如有变更，恕不另行通知。

YONGNUO

## 85F1.85 DF DSM MEDIUM TELEPHOTO PRIME LENS

### USER MANUAL for S

#### Thank you for purchasing YONGNUO product!

Before using the product, please read the instruction manual carefully to ensure that you use the product properly. Please keep the manual properly for future reference.

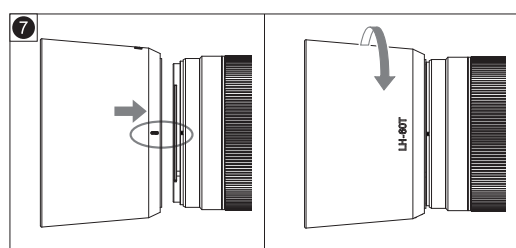
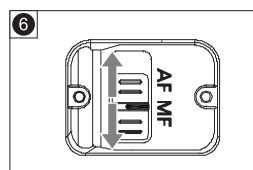
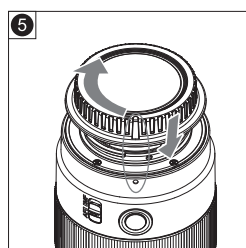
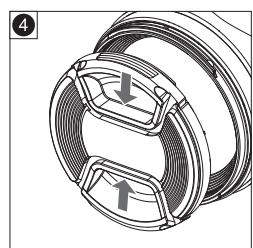
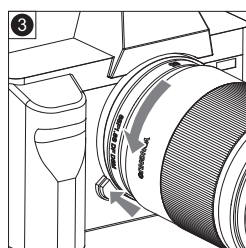
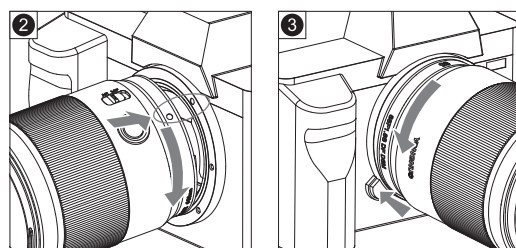
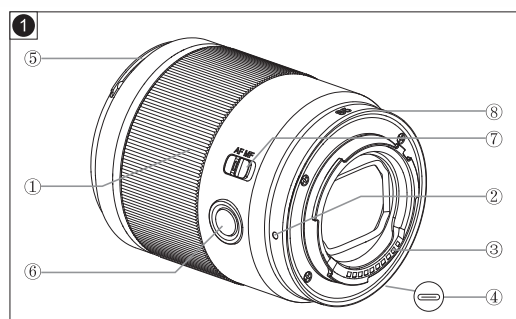

#### Safety Precautions

- \* Please do not look at the sun or bright light source through the lens or camera, otherwise it might cause visual impairment.
- \* Whether the lens is mounted on the camera or not, please do not place the lens under the sun without lens cap covered, otherwise the lens might gather light and cause a fire. Please cover the lens with lens cap when not in use.
- \* Please keep the lens out of reach from children.
- \* Please do not disassemble or modify this product.

#### Nomenclature①

- ①Manual focus ring
- ②Lens mounting mark
- ③Electronic contact
- ④USB interface
- ⑤Lens hood mounting mark
- ⑥Fn Multi-function button
- ⑦Focus mode button
- ⑧Rubber ring

#### Mounting and Detaching the Lens

For details on mounting and detaching the lens, please refer to your camera's user manual.

##### Mounting the Lens ②

Please align the white mounting mark on the lens with the same mounting mark on the camera, then rotate the lens clockwise until 'click' is heard.

##### Detaching the Lens ③

Press the lens release button on the camera, rotate the lens anticlockwise until stop, then detach the lens.

- \* After detaching the lens, please place the lens with the rear end up to prevent lens and electronic contact from getting scratched. If the electronic contact get dirty or contaminated with fingerprints, please clean them with soft cloth.
- \* When detaching the lens, please cover it with dust cap. Please mount the dust cap properly: align the mounting mark on the dust cap with the same mounting mark on the lens, then rotate clockwise. If you need to detach the lens cap, rotate it anticlockwise.

#### Focus Mode ④

The lens supports auto focus and manual focus. To set the focusing mode on the lens: slide the focusing mode switch to the corresponding position. To set the focusing mode on the camera, please refer to the camera manual.

**For AF photography:** both the camera and lens should be set to AF.

**For MF photography:** either or both the camera or lens should be set to MF.

- \* If the lens is not mounted on the camera or the camera is switched off, the focus cannot be adjusted.

#### Fn Multi-function button

Through the camera "focus hold button" custom settings, you can freely assign the required functions for Fn button. Reasonable allocation of Fn button can quickly call up a function menu or execute a shortcut operation, so as to reduce the time of searching the camera menu and improve the creative efficiency.

- \* Focus hold button function settings need to be supported by the camera, please refer to the camera manual for details.

#### Lens Hood

Mounting lens hood can protect lens and block scattered rays which might cause stray light or ghosting.

**Mounting:** Align the mounting mark on the lens hood with the mounting mark on the front lens, then rotate the lens hood clockwise until stop. ⑦

**Detaching:** Rotate the lens hood anticlockwise until stop, then take down the hood.

- \* The hood can be reverse-mounted on the lens for storage.
- \* If the lens hood is mounted improperly, part of the picture may be blocked.
- \* When using built-in-flash or on-camera flash, it is suggested to take out the hood so as not to block the flash light.

#### Filters(Sold Separately)

You can attach a filter in 58mm diameter to the filter mounting thread on the front of the lens.

- \* Only one filter can be attached each time.

#### Firmware Upgrade

This product supports firmware upgrade, please visit website <https://www.hkyongnuo.com/xzyzc> to download the latest upgrade software and firmware. Before use, we suggest you upgrade the lens to the latest firmware for the best user experience.

Upgrade method: Take the lens off the camera, connect the lens with the computer via the USB Type-C cord, start the upgrade software and complete the upgrade operations according to the software prompts.

#### Maintenance and Storage Precautions

- \* Please avoid collision or placing the lens directly in extremely hot, cold and humid environment.
- \* For long storage, please choose a cool, dry and well-ventilated place. Please keep away from pest control pills or places where the pest control pills give off gas, to protect the lens coating.
- \* For cleaning the dirt or fingerprint, you can use soft and slightly wet lens cleaning cloth or lens paper, please do not use solvents, benzene or other organic cleaners.
- \* Please be careful when it rains or being placed near water source, please do not get it wet, if the inner parts, lens or electronic parts get damaged by damp, it may be unable to repair.
- \* Temperature jump may result in condensation of mist and water-beads, therefore, when you get in a warm indoor environment in cold weather, you had better put the lens in sealed plastic bag to wait until the lens temperature is close to room temperature. Please do the same when the lens is taken from warm to cold environment.

#### Troubleshooting

##### 1. In manual focus, the image quality is adjusted to the clearest, but the image is still blurry.

Please check if there are fingerprints or dirt on the front and rear lens, if so, please use soft and slightly wet lens cloth or lens paper to wipe up.

##### 2. AF does not work properly.

Please make sure that both the camera and lens are set to AF.

##### 3. Communication Error When Lens is Mounted on Camera

Please make sure the lens is mounted properly; please check if the lens contacts and camera contacts are soiled or scratched, if it is soiled, please use soft cloth to wipe up, if it is scratched, please return for repair.

##### 4. Other Problems

Please try turning off the camera and taking out the camera battery, then put back the battery, try rebooting the camera. If problems still exist, please contact YONGNUO after-sale service center at 400-001-3888 or email to [service@hkyongnuo.com](mailto:service@hkyongnuo.com) for enquiry.

#### Specification

Focal Length		85mm
Angle of view	Diagonal	28.83°
	Vertical	16.5°
	Horizontal	24.12°
Lens Mount		E Mount
Lens Frame		Full Frame
Lens Construction		9 elements in 8 groups
Aperture Blades		7
Minimum Aperture		F/16
Minimum Focusing Distance		0.8m
Maximum Magnification		0.13x
Driving System		Digital stepper motor
Filter Diameter		58mm
Max. Diameter x Length		About φ67×87mm
Weight		About 385g

- The lens length refers to the distance from the mounting side to the lens front end.
- Unless special stated, the dimension and weight is only suitable for lens. The Aperture can be specified by the camera.

The electronic edition of this user manual can be acquired from <https://www.hkyongnuo.com/xzyzc>.

The function and data listed in this manual are acquired according to YONGNUO testing conditions. The design and specification are subject to change without notice.