

Safety Warning

To avoid fire or electrical shock, please keep this product away from rain or moisture.

When handling the battery, to avoid short circuit, please make sure the battery contacts are securely packed and please comply with local provisions about battery disposal.

Please keep the batteries or the parts which are easy to be swallowed accidentally away from children, please contact a doctor immediately when this incident happens.

Please keep the charging device out of reach of children to avoid child choking or electric shock caused by power cord.

Do not use flash parts at close distance from human's eyes, otherwise it may cause injury to human retina.

Do not use the speedlite towards people who needs high attention, otherwise it may cause safety accident, if this happens, please take out the batteries and stop using this product.

- This product falls down or is shocked severely and the internal parts of the product are exposed.
- The corrosive liquid of the battery leaks out, please take out the battery with gloves.
- The product emits strange odour, overheats or smokes.

Please do not take apart or repair this product, if you contact with high-voltage circuit of internal part of the product accidentally, it may cause electric shock.

If the speedlite or accessory are unused and stored, please take out the battery and cover it with protective cap.

Product Features

● Super-powerful Portable Lithium Battery System

Equipped with 2000mAh big-capacity lithium battery, number of flash firing is over 750.

● Imported High-quality Battery Core, Built-in Protective Circuit.

Adopts imported high-quality lithium core, built-in overcharge protection, short-circuit protection and thermal-shutdown circuit, with advantages of long service life, high safety.

● Ultra-fast Charging Recycle System

Recycle time of full output is only 1.5s, you won't miss any splendid moment.

● Supports USB Firmware Upgrade

Equipped with USB port, please visit YONGNUO official website to download the latest firmware and update the flash to ensure the best compatibility and performance of the flash.

● Compatible With YONGNUO 602/603 Wireless Trigger System

Fully compatible with YONGNUO radio transmission trigger signal of YN720/YN685/YN560 IV/YN660/YN560 III/YN560 TX/RF605/RF603/RF602, there are 16 channels available for choice, the effective trigger distance is up to 100m.

● Supports Radio Transmission Master Control, Realizes 6-group Flash Control Function Easily.

As master control unit, YN720 is equipped with 6-group flash control function, which supports remote control of flash mode, flash output, focal length, stroboscopic times and stroboscopic frequency of YN720/YN685/YN560 III/YN560 IV/YN660.

● Supports Radio Transmission Slave Function

As slave unit, YN720 can receive the radio transmission trigger signal from YONGNUO YN720/YN560 IV/YN660/YN560 TX/RF605/RF603/RF602.

● GN60@ISO100, 200mm

High Guide number 2.4GHz radio transmission speedlite, supports M/Multi flash mode.

● Supports Real-time Display of Battery Remaining Capacity, Supports Power Saving Function

Displays battery remaining capacity in real time, which helps user know the battery status easily; Power saving design, the product enters sleep mode or powers off automatically after being idle for a long time.

● Supports Lamp Head Electric Zoom Function.

Supports manual zoom, you can set flash coverage in the range of 20~200MM.

● Equipped with large dot-matrix LCD screen.

The interface display is simple and straightforward, the operation is easier.



Catalogue

Warnings	1
Product Features	2
Quick Guide	4
Components Description.....	5~8
Battery Charge.....	9
Product Assembly and Disassembly.....	10
Basic Function.....	11~14
Advanced Applications.....	15~16
Wireless Flash Shooting.....	17~20
C.Fn: Custom Function Setting.....	21~22
Troubleshooting Guide	23
Specifications	24~25

Conventions used in this user manual:

- In order to learn and master the operation of this speed-lite, at the meanwhile you read this manual, please take user manual of your camera as reference.
- In every operating step, we assume that both camera and speed-lite are power on.

Icons used in this user manual

-  : Supplementary information
-  : Long press the button
-  : Short press the button

Quick Guide

If you do not have enough time to read through this user manual, please read this chapter.

1. Avoiding overuse of full power output helps extend the service life of this product effectively.
2. Short press [MODE] to switch flash mode, long press [MODE] to enter trigger mode selection interface, turn [⊗] to select trigger mode.
3. The functions displayed above the four function buttons vary according to the current setting status, such as brightness [+/-]、channel [CH]、grouping [Gr]、activation [ACT].
4. In common on-camera and off-camera trigger mode, short press [Zm/C.Fn] to enter focal length adjustment of this speedlite: In master control trigger mode, short press [*ZOOM] to enter focal length adjustment of * group.
5. Long press [Zm/C.Fn] or short press [C.Fn] to enter custom setting interface.
6. Turn [⊗] to adjust parameters, press [SEL/SET] button to save the setting.
7. Press button 2 and 3 together to restore the flash parameter of the speedlite to default setting (trigger mode, flash mode, flash output, focal length)
8. In power-off mode, press and hold [MODE], then turn on the speedlite to enter firmware upgrade interface.

Components Description

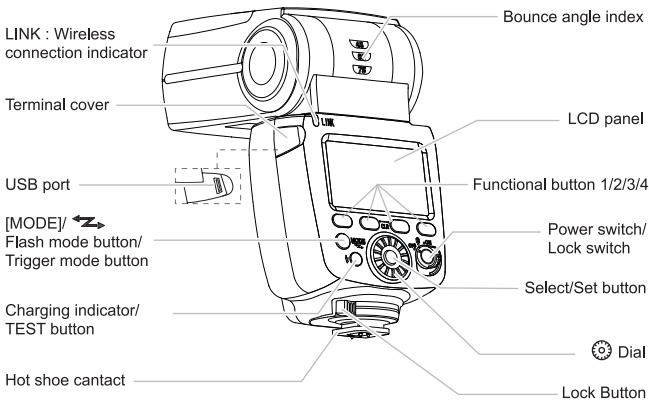
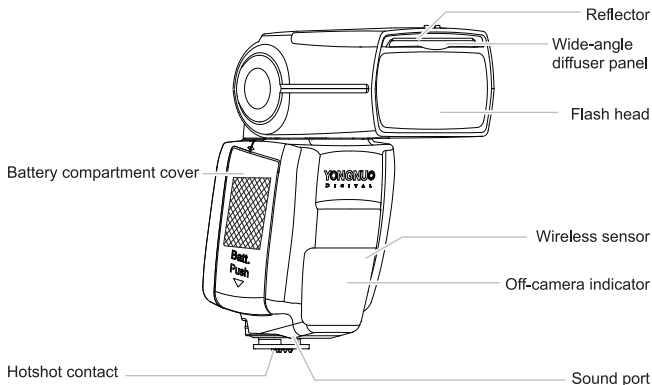

LCD Screen Display

M mode

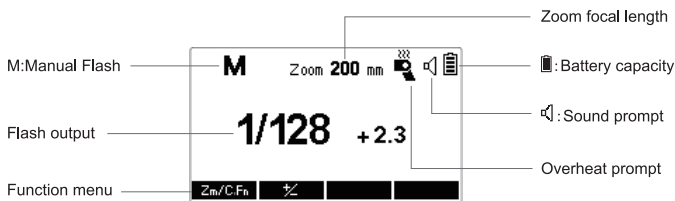

Multi mode

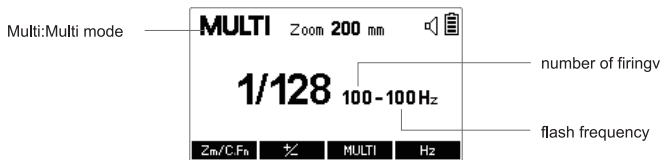

Radio Master Control Unit

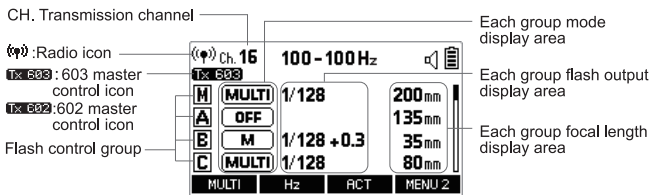

Radio Slave Unit

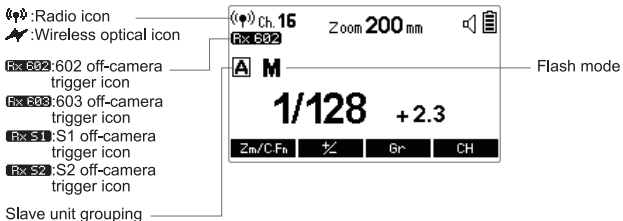

Status of Indicator

Meaning of Indicator Light

Status of Charging Indicator	Meaning	Method
Red light	The speed-lite is fully charged and can be used.	Normal.
Blue light	The speed-lite has not been fully charged.	Waiting for completion of charging.
Blue light blinking	A. Low battery; the speed-lite is about to shut down B. Overheat prompt	A. Please replace batteries. B.Reduce flash frequency or stop using the speed-lite until it cools down.
Red light blinking	Overheat prompt	Reduce flash frequency or stop using the speed-lite until it cools down.
Red light and blue light blinking	Overheat protection mechanism is activated.	Stop using the speed-lite/shut down the speed-lite until it cools down.

Components Description

LINK indicator

Indicator light status	Meaning
Blue light	Communication statu
Red light	Send and receive trigger signal

Sound Prompt

The Sound Form	Meaning	Method
Tick twice	The sound indicator is enabled; the speed-lite is started and ready to fire.	Normal
Tick-tick twice -tick twice	The charging has not been completed.	Wait for completion of charging.
Tick-a long sound	The speed-lite is fully charged and can be used.	Normal
Tick continuously and quickly	Low battery; the speed-lite is about to shut down.	Please replace the batteries.
Tick-tick-tick-	The speed-lite is in sleep mode and it shuts down automatically.	Please turn off the speed-lite and restart it.

Battery Charge

1.Take out the battery cover

2.Install the battery

- Insert the battery to charger (YN530),and make sure the battery is installed properly,as shown in the figure. For removing the battery,please operate in reverse order according to the figure.

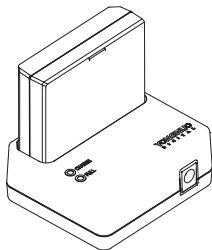

3.Connect the power cord with AC adapter

- Connect the power cord with AC adapter,and connect the output port of the AC adapter to the input port of the charger.

4.Insert the power cord plug to the socket,the speedlite will be charged automatically.

Charging indicator status:red light means the speedlite is being charged,green light means it is fully charged.



- 1.Do not connect positive and negative electrode of battery.
- 2.Do not put associated equipment in water or other liquid.
- 3.Please keep the battery away from fire source or other high-temperature objects.
4. Please use specified charger.
- 5.When the speedlite is not used,please take out the battery.When storing the battery,please cover it with protection cap.

Mount and Remove

1.Install Batteries

Slide the battery compartment cover in the direction of the arrow as shown.

Insert the batteries according to the label inside the battery compartment and make sure the direction of the battery contact (+/-)is correct.

Close the battery compartment cover in the direction of the arrow as shown.

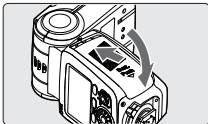
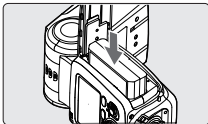
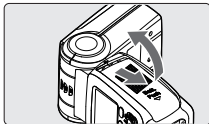

2.Attaching to the Camera & Detaching from the Camera

Slip the speedlite's mounting foot all the way into the camera's hot shoe.

Slide the mounting foot lock lever to the right side as the arrow shown until a "click" sound is heard.

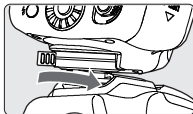
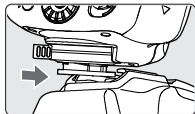

3.Detaching

Slide the [lock button] to the left side and detach the speedlite.

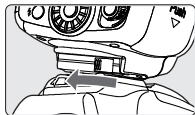

Basic Function

1. Power-on and Power-off

Set the power switch to [ON] position, the speedlite will turn on and start charging. After turned on, the [Charging Indicator] will bright with red light which indicates it can flash.

If the battery is low, and the speedlite cannot be fully charged in 25s, the <Charging Indicator> will bright with blue light, the LCD screen shows low-battery icon, and the speedlite will shut down automatically. At this moment, please change batteries.

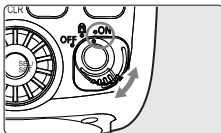

2. Key Locking Function

Switch the [Power Switch] button to the <LOCK> position could lock the [] and buttons of the speedlite. Using this function prevents unexpected changes of the parameters. When this function is turned on, the screen will display < LOCKED > below.

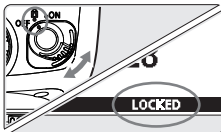

3. Test Flash

When the <Indicator light> turn in red, you can press the [] button to test if the speedlite flash normally.

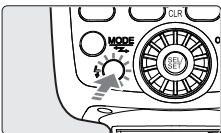

4. M mode flash

Short press the [MODE] button to set the flash mode to M mode. In M mode, you can set flash output as your requirement by short press the function button [+/-], when the <Flash output> displays on the screen, you can adjust the flash output through the []. Adjustment range of flash output is 1/128~1/1, and the output can be divided into 8 grades, each has maximum 3 grades for fine adjustment, with grade 0.3EV, 0.5EV as

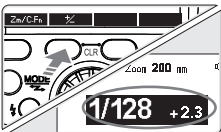
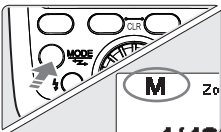



Basic Function

adjustment increment, total 29-grade fine adjustment. When shooting, you just need to set the flash output, adjust the camera and press the camera shutter, the flash will flash at the camera sync signal.

5. Multi Flash Mode

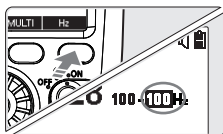
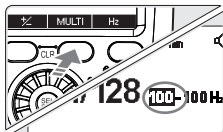
Short press the **【MODE】** button will switch the flash mode to MULTI mode. In Multi (stroboscopic) mode, the speedlite will flash according to the flash output, flash frequency and number of flashes you set. The setting method of flash output is the same as M mode, the flash output range is 1/128-1/64-1/32-1/16-1/8-1/4. Through the function button **【MULTI】** to select the number of flashes, short press the function button **【Hz】** to select the flash frequency, enter the parameter setting status, rotate the **【⊕】** to adjust the flash frequency and number of flashes. The range of flash frequency and number of flashes are both between 1 ~ 100. When the number of flashes set to **<-->**, indicates the speedlite will continually flash until the shutter is closed or the battery runs out.



 When in low battery, the charging speed of speedlite will be slow, which may cause the leakage of the stroboscopic flash. In this situation, please reduce the flash frequency or change new battery. The maximum number of stroboscopic of flash will be limited by the flash output and flash frequency.

6. ZOOM: Set the flash range

Short press the function button **【Zm/C.Fn】** and **【ZOOM】** button, the focal length numerical shown on the LCD screen and adjust the flash coverage through the **【⊕】** button, the flash coverage can be switch between 20, 24, 28, 35, 50, 70, 80, 105, 135, 200mm.

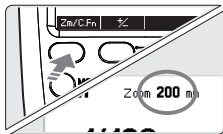

 Using wide diffuser, the flash coverage will be extended and lock to 14mm.

7.Power Saving Mode

The product is equipped with power saving mode, the function can be achieved by setting through custom function, related operations and details please refer to the subsequent “Custom Function” chapters. After the power saving mode is turned on, the flash will automatically enter dormant state, after a period of idle time, and the flash will be automatically shutdown. When the flash is in dormant state, the flash will be awakened by pressing the [⚡] button.

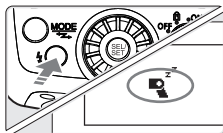

8.Overheat Protection

After continuous flash, the internal temperature of the flash will rise, and after reaching a certain temperature, the flash will appear overheating warning.

If the speedlite is used too frequently, the overheat protection function will be triggered; the <Overheat protection> icon will be displayed on LCD panel, and the speedlite will be locked. In such case, please wait for 10 minutes or longer before continuing use. To prevent impact in shooting, please try to use 1/4 or lower output when need high speed shooting.

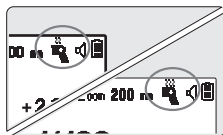

overheating warning



Overheat Protection

When the battery temperature is too high, the flash will activate the battery protection mechanism. The screen will display the warning icon and lock the flash. Please take out the battery and wait for the battery to cool before continuing use.



The recycle time may be longer when the flash shown warning of overheating. Please reduce flash frequency or flash output when the flash shown warning of overheating.
When removing the battery after continuous flashes, be careful that the battery may be hot.

9.Voice Prompt

You could turn on or turn off the voice prompt through the custom function setting options C.F N06, after turned on the flash would make different sound prompt its working status, the specific sound mode and meaning please refer to the "Components" section.

10.Off Camera Status Indicator Light

The off camera status indicator light can reflect the recycle status of the flash in real time, so that you could master the recycle status of the slave unit from a great distance.After the function turned on, the indicator light will blink when the flash is full charged.



11.Automatic Setting Saving

Through the switch button turn off the speedlite,it will automatically save the current settings,which will convenient to your next use.

12.Clear the Flash Settings

Press the function button 2 and function button 3 for around two seconds, except the custom function Settings,the flash parameters including the trigger mode, flash mode, flash output, and focal length will be restored as default Settings.

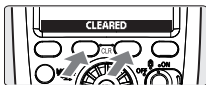

To restore the custom function settings,please refer to the custom settings section.

13.Firmware Upgrade

The product supports firmware upgrade,the user could log on the official website www.hkyongnuo.com to download the most updated software and firmware for upgrade. The method is as follow:

- Connect the computer with the USB cable.
- When the speedlite is turned off,hold the [MODE] button and enter into the upgrade interface.
- Turn on the upgrade software, follow the software and upgrade operation.



Advanced Applications

1.Second-curtain Sync

After turning on the second-curtain synchronization , the speedlite will flash at the moment the shutter is closing.Use slow-speed shutter and the second-curtain synchronization will produce trailing smear for the object.The second-curtain synchronization function requires the camera to support itself, for setting method please refer to the camera manual.

2.High-speed Continuous Shooting

The flash can support the high-speed continuous shooting function. Please set the camera in the continuous shooting form and then shoot.



The quantity of photos that can be continuous shot is related with the flash output setting. Please use the battery with enough electric quantity.

3.Remote Wireless Flash

The YN720 supports remote wireless flash:the effective flash distance of the 2.4 GHz radio flash shooting (602/603 wireless flash system) can reach up to 100 meters;the furthest distance of indoor wireless optical transmission can be up to 25 meters,while the furthest distance of outdoor can be up to 15 meters. Related operations and details please refer to the Wireless Flash shooting chapters.

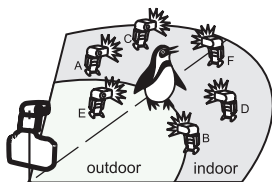

4.Reflection Flash

Bounce flash means to take photos by making flash light head aimed at wall or ceiling and using the light reflected back from the ceiling or wall to light the desired object, so that the shade behind the object can be decreased to get more natural shooting effect.

If the wall or ceiling is too far, the bounce flash may be too weak to get enough exposure. The wall or ceiling should be even and white in order to get efficient reflection; if the reflection surface

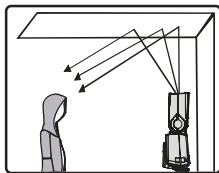

Advanced Applications

is not white, color cast may appear in photo.

5. Use Reflection Board for Shooting

With the Reflection board in flash, pull out the Reflection board and the Wide panel out from the light head at the same time and then push the Wide panel back. In such case, if this product is being used to take photos, it will produce a highlighted point on the eyes of the subject and thus make the eyes charming (catching light). This function can reach optimal effect when the flasher head is up 90°.

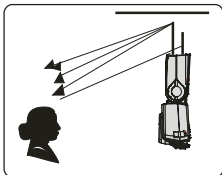

6. Use Wide Panel

Pull out the Wide panel, push back the Reflection board and arrange them as per the figure; in such case, the flash scopes will extend to 14 mm, the flash range will be enlarged and the effect will be softer and more natural.

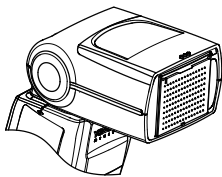

When using the wide panel, the flash coverage will expand and lock to 14mm.

Wireless Flash Shooting

1. Wireless Transmission

YN720 can receive 2.4GHz wireless triggering signal from YONGNUO 602 and 603. In wireless flash shooting, YN720 can be used as master unit or slave unit.

When YN720 is used as master unit, it can directly remote control the flash mode, flash output and focal length of slave unit (YN720, YN560III, YN560 IV, YN660 or YN685).

When YN720 is used as slave unit, it can receive wireless triggering signal from trigger with 602/603 master control function (RF602, RF603, YN560-TX, etc.) or speed-lite (YN560IV, YN660, etc.). If master unit is supported, the flash mode, flash output and focal length of YN720 can be controlled and changed by master unit.

● Master Unit Settings

Set the trigger mode: Long press [MODE] button, enter into trigger mode selection interface, rotate [◂] to select master trigger mode < (Tx) Tx 603 > or < (Tx) Tx 602 >, press [SET] button to save and exit.

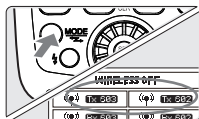

Setting flash mode of master unit and slave unit of each group: Short press function button [Gr], enter into control group select state, rotate [◂] to select the group* to be set, and short press function button [*MODE] to switch flash mode (M/Multi/OFF) of *group. OFF means flashlight of this group is prohibited.

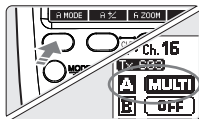

* means flash group M/A/B/C/D/E/F. When M group is selected, it means this moment the flash parameter of master unit is controlled. When A~F group is selected, it means this moment the flash parameters of corresponding slave unit is controlled.

Set the flash output and focal length: Short press function button [Gr] to enter into control group select state, and rotate [◂] to select the group* to be set; short press function button [*+/+] to enter into flash output adjustment state of *group, short press function button [*ZOOM] to enter into focal length

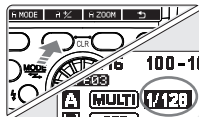

Wireless Flash Shooting

adjustment state of *group, and adjust the parameters through [⊙].

When adjust the flash parameter of each group from the master unit, the adjusted parameter of the last time will be synchronously transmitted to the corresponding slave unit.

● Slave Unit Settings

Set the trigger mode: Long press [MODE] button to enter into trigger mode selection interface, rotate [⊙] to select off-camera trigger mode < (Rx 603) > or < (Rx 602) >, then press [SET/SEL]

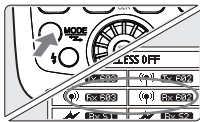

Note: When YN720 is in wireless flash shooting, the wireless triggering signal of master unit should be set as same as the slave unit. That is to say, set the signal of both units as 602 triggering signal or set the signal of both units as 603 triggering signal. If not, it cannot trigger normally.

button to save and exit.

When YN720 is used as wireless slave unit, it supports being set as 6 groups (A/B/C/D/E/F). There are two setting methods: ① On the slave unit, short press the function button [Gr] to switch off-camera group; ② On the slave unit, short press the function button [Gr] to select group, and set group through [⊙].

When YN720 is used as slave unit, the flash mode, flash output and focal length can be set from the slave unit. The setting method is same as ordinary on camera trigger mode settings. For more specific setting methods please refer to “Basic Function” chapter.

● Transmission Channel Settings

In public, if other photographers are shooting with wireless multi-flash or other wireless equipment, you can change transmission channel to avoid interference. There are 16 channels (CH1~CH16) of 602/603 wireless triggering system for selection. Setting method: Short press function button [CH] to enter into channel setting interface, rotate [⊙] to select channel, then press [SET/SEL] or function button [M] to save and exit.

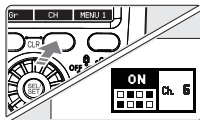

In 602/603 wireless transmission flash shooting, please make sure the transmission channel of the master unit is set as same as the slave unit. If not, it cannot trigger normally.

Activate YN560 III

If your YN560 III doesn't support grouping function, it means this light has not been activated, you can activate it through YN720. Activate as below:

- Both YN720 and YN560 III select same wireless triggering signal (602 or 603). YN720 set as TX master unit, and YN560 III set as RX slave unit.
- Set the channel of YN720 same as YN560 III.
- Enter into function menu MENU2 of YN720, short press function button [ACT] to enter into active signal send state. When YN560 III receives active signal, short press [OK] button on YN560 III to confirm activation. After activation completed, there is a grouping display area showing on the screen of YN560 III.



2. Optical Transmission

When YN720 is used as slave unit, it supports two optical transmission wireless flash shooting modes: S1 and S2. Setting method: Long press [MODE] button to enter into trigger mode selection interface, and rotate [⊙] to select < ⚡ Rx S1 > or < ⚡ Rx S2 >.

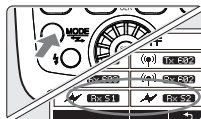

S1 and S2 off-camera triggering modes are respectively suit for manual flash environment and TTL flash environment. When YN720 works in S1/S2 mode, the flash mode defaults to M mode. The setting method of flash output is same as ordinary on-camera M mode. For more details please refer to “Basic Function” chapter.

S1 mode: When the flash is in S1 mode, it will fire synchronously with the first flash of the main light. The result is as same as using wireless trigger. To normally use this mode, the main light should be set as manual flash; the TTL flash system supports pre-flash and the red-eye reduction function allows multi-flash should not be used.

S2 mode: S2 mode is also called as “pre-flash cancel mode”. This mode is similar with S1 mode, but it supports neglecting the pre-flash given by TTL flash. Therefore, it supports master flash working in TTL mode. In particular, if your speed-lite in S1 mode cannot fire properly and

Wireless Flash Shooting

synchronously with the built-in flash, you can try S2 mode.



When using the speed-lite in S1 or S2 mode, the following situation shall be avoided; if not, it may lead the flash out of sync: the red-eye reduction function of the main light is used; the wireless flash mode of the main light is used; ST-E2 is used as flash controller.

C.Fn: Custom Function Settings

The flash function can be defined according to personal requirements. Long press the function button [Zm/C.Fn] or [C.Fn] to enter the custom function menu, and rotate [⊙] to select the custom function items (Number, such as C.Fn 01). Short press [SET] button to enter the sub-menu, rotate [⊙] to change the function settings; short press [SET] button to save and exit sub-menu to complete custom function settings. After that, press [⏪] button and go back to the shooting interface.

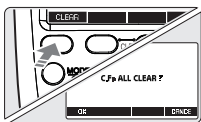
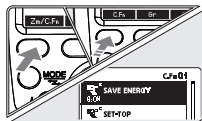

After entering the custom function menu, short press [CLEAR] button and short press [OK] button, the custom function settings will be restored to factory default.

YN720 supports custom function as below:

C.Fn 01 Power saving function

0:ON Turn on the power saving function

1:OFF Turn off the power saving function

C.Fn 02 Sleep in on-camera trigger mode and auto power off timer

0:3-30 min 3-30 min Enter sleep mode after being idle for 3 min, auto power off after sleeping for 30 min

1:15-60 min 15-60 min Enter sleep mode after being idle for 15 min, auto power off after sleeping for 60 min

2:30-120 min 30-120 min Enter sleep mode after being idle for 30 min, auto power off after sleeping for 120 min

C.Fn 03 S1/S2 slave unit auto power off timer

0:30 min Auto power off after being idle for 30 min

1:60 min Auto power off after being idle for 60 min

2:120 min Auto power off after being idle for 120 min

C.Fn 04 602/603 602/603 slave unit sleeps and auto power off timer

0:5-30 min Enter sleep mode after being idle for 5 min, auto power off after sleeping for 30 min

1:15-60 min Enter sleep mode after being idle for 15 min, auto power off after sleeping for 60 min

C.Fn: Custom Function Settings

2:30-120 min Enter sleep mode after being idle for 30 min, auto power off after sleeping for 120 min

C.Fn 05 LCD backlight

0:12 sec The display time of LCD backlight is 12 seconds

1:ON Background light long on

2:OFF Turn off the background light

C.Fn 06 Sound prompt

0:ON Turn on sound prompt

1:OFF Turn off sound prompt

C.Fn 07 Backlight brightness

The backlight brightness can be adjusted. There are 11 levels for option.

C.Fn 08 LCD display contrast control

The LCD display contrast control can be adjusted. There are 7 levels for option.

C.Fn 09 Slave unit indicator light

0:ON Turn on the slave unit indicator light

1:OFF Turn off the slave unit indicator light

C.Fn 10 M mode exposure level increment

0:1/3 exposure level increment is 1/3

1:1/2 exposure level increment is 1/2

C.Fn 11 Firmware version

Display the information of current version for the flash.

Troubleshooting Guide

1.Power does not turn on or the flash does not fire.

Make sure that the batteries are installed in the correct orientation, and check if the battery capacity is sufficient or not.

Make sure that the flash hot-shoe completely slides into the camera hot-shoe stand, and the fixed knob of the speed-lite is locked.

2.The flash doesn't fire in optical transmission.

When this flash is for outdoor use, please keep the wireless sensor of the flash from direct sunlight. Please make sure the slave unit is placed in the effective trigger range.

3.The flash doesn't fire in wireless transmission.

Please make sure the wireless trigger signal (602 or 603) and channel of the master unit are set as same as the slave unit. At the meanwhile, please place the slave the unit in the effective wireless transmission range of the master unit.

4.Photos are underexposed or overexposed.

Check if the set shutter, aperture and ISO are too near the flash limit or if some settings including exposure compensation is relation to flash are proper.

5.Vignetting appears in photos or only part of the subject is illuminated.

Please check the current coverage of focal length and make sure if the lens focal length exceeds the coverage range of the flash. If it exceeds the product's zooming range, please try to pull out the wide-angle diffuser to expand the flash range.

6.The flash works abnormally.

Try to turn off the power of the flash and the camera, take the flash off from the the camera, and restart the flash and the camera. If the flash still works abnormally, please contact YONGNUO customer service center at 400-0013-888 or email to service@hkyongnuo.com.

Specifications

Circuit design	Insulated Gate Bipolar Transistor (IGBT)
Guide No.	60 (ISO 100, 200mm)
Flash mode	M, Multi
Trigger mode	set-top mode, radio wireless master mode, radio wireless slave mode, wireless optical slave mode
Zoom	20, 24, 28, 35, 50, 70, 80, 105, 135, 200mm
Vertical rotation angle	-7~90 degrees
Horizontal rotation angle	180 degrees for each
Power supply	YN-B2000 Li-ion battery*1
Lighting times	750 times (YONGNUO Li-ion battery YN-B2000 used)
Recycle time	Approx 1.5s
Flash color temperature	5600k
Flash time	1/200s~1/20000s
Flash control	8 levels output control (1/128~1/1), 29 levels of fine tuning
External interface	Hot shoe, USB port
Radio transmission triggering distance	Up to 100m
Optical transmission triggering distance	20~25m indoors, 10~15m outdoors
Additional features	Master flash, off-camera flash, second curtain sync, electronic flash head zooming, sound prompt, automatically saving setting, power saving mode, overheat protection, custom function (C.Fn), firmware upgrade
Dimensions	Approx 64×78×210mm (extended state)
Net weight	417g
Contains items (Kit)	Speedlite (1), protecting bag (1), mini stand (1), user manual (1), product qualification certificate (1), power adapter (1), power cord (1), charger (1), Li-ion battery (1)
Contains items (only flash unit)	speedlite (1), protecting bag (1), mini stand (1), user manual (1), product qualification certificate (1)

Guide Number (ISO 100, in meters / feet)

Flash Output	Flash Coverage (mm)					
	14	20	24	28	35	50
1/1	15/49.2	26/85.3	28/91.9	30/98.4	36/118.1	42/137.8
1/2	10.6/34.8	18.4/60.4	19.8/65	21.2/69.6	25.5/83.7	29.7/97.4
1/4	7.5/24.6	13/42.7	14/45.9	15/49.2	18/59.1	21/68.9
1/8	5.3/17.4	9.2/30.2	9.9/32.5	10.6/34.8	12.7/41.7	14.8/48.6
1/16	3.8/12.5	6.5/21.3	7/23	7.5/24.6	9/29.5	10.5/34.4
1/32	2.7/8.9	4.6/15.1	4.9/16.1	5.3/17.4	6.4/21	7.4/24.3
1/64	1.9/6.2	3.3/10.8	3.5/11.5	3.8/12.5	4.5/14.8	5.3/17.4
1/128	1.3/4.3	2.3/7.5	2.5/8.2	2.7/8.9	3.2/10.5	3.7/12.1

Flash Output	Flash Coverage (mm)				
	70	80	105	135	200
1/1	50/164	53/173.9	58/190.3	59/193.6	60/196.9
1/2	35.4/116.1	37.5/123	41/134.5	41.7/136.8	42.4/139.1
1/4	25/82	26.5/86.9	29/95.1	29.5/96.8	30/98.4
1/8	17.7/58.1	18.7/61.4	20.5/67.3	20.9/68.6	21.2/69.6
1/16	12.5/41	13.3/43.6	14.5/47.6	14.8/48.6	15/49.2
1/32	8.8/28.9	9.4/30.8	10.3/33.8	10.4/34.1	10.6/34.8
1/64	6.3/20.7	6.6/21.7	7.3/24	7.4/24.3	7.5/24.6
1/128	4.4/14.4	4.7/15.4	5.1/16.7	5.2/17.1	5.3/17.4

The electronic version manual can be downloaded from www.hkyongnuo.com
The functions of this manual are based on the test conditions of our company.
Further notice will not be given if the design and specifications change;
The YONGNUO logo in this manual includes the registered trademark or
trademark of SHENZHEN YONGNUO PHOTOGRAPHY EQUIPMENT Co.,
Ltd in China or/and other countries (regions). All other trademarks are the
property of their respective owners.